

advertising formats
inserts

SCENT STRIP

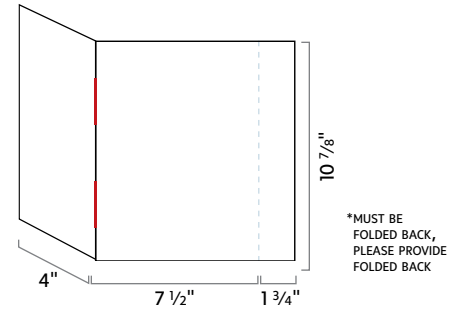

BUSINESS REPLY CARD

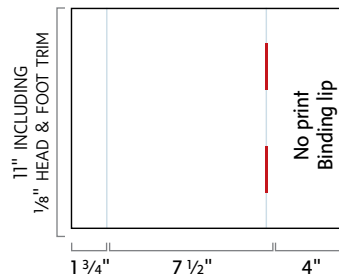
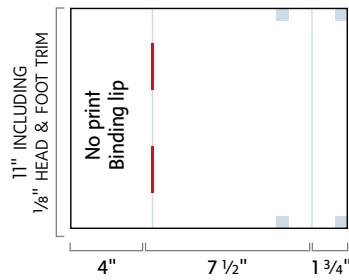
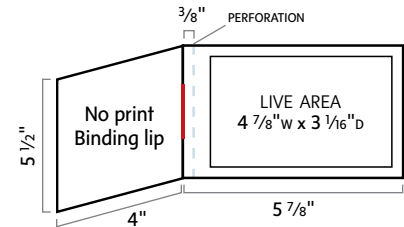
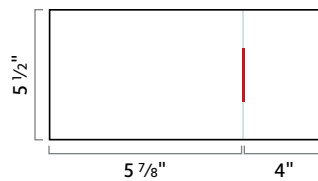
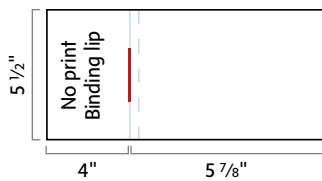

SINGLE-PAGE STITCHED-IN INSERT

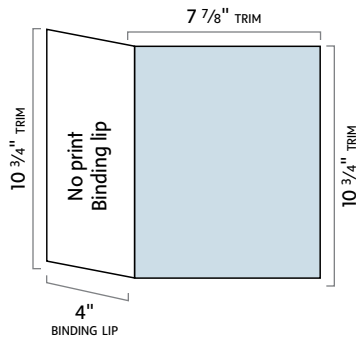

MULTI-PAGE STITCHED-IN INSERT

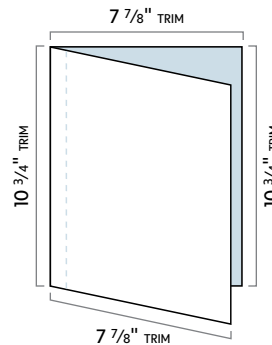

TIP-IN INSERT

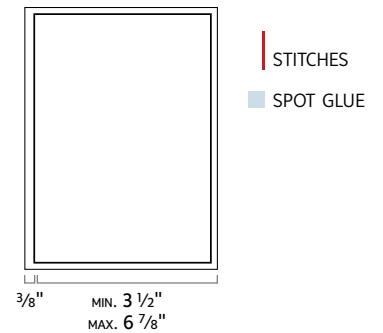

LOW FOLIO FRONT TO CENTER: 1/8" BLEED
HIGH FOLIO CENTER TO BACK: 1/8" BLEED + 3/8" LIP
*MULTI-PAGE: MUST BE PRESTITCHED OR UNTRIMMED FORM

Packaging and receiving criteria for inserts supplied by the client

- Inserts can be supplied either directly by the client or by the client's supplier
- A minimum of 2% must be added to the quantity for spoilage
- Inserts must be delivered in good quality, uniform boxes, weighing a maximum of 35lbs, in a manner that keeps them from moving around
- Boxes must be delivered on good quality standard size skids
- 25 samples of each insert must be supplied to Report on Business magazine to:

Isabelle Cabral
The Globe and Mail Centre
351 King Street East, Suite 1600
Toronto ON, M5A 0N1

The following information must appear on the delivery slip

- Client's name
- Item or description of the content
- Name of the magazine to be inserted into
- Issue date
- Quantity per box and total quantity
- **The information above must appear on each box**

Insert Shipping Address

Transcontinental Printing, Imprimerie Interweb Inc.
1603 Montarville Blvd., Shipping & Receiving, Door 10
Boucherville QC J4B 5Y2
tel: 450-655-2801 fax: 450-655-0765
Monday to Friday 8AM to 5PM excluding holidays

